

Panaria Context



R10 Naturale
R11 Strutturato, 20 mm



V2



Lasittamaton kuivapuristelaatta
(UGL)

”Moderneja ja klassisia ratkaisuja, joissa yhdistyvät alkuperäisen materiaalin tyylikäs luonne keramiikan kestävyys ja toimivuuteen.”



Square



Loft



Store



Hangar



Mansion

20mm paksut laatat ulkokäyttöön

PROTECT

SUPERFICIE ANTIBATTERICA
ANTIMICROBIAL SURFACE

with MICROBAN®



5 VÄRIÄ

SQUARE, LOFT,
STORE, HANGAR,
MANSION



2 PAKSUUTTA

9,5 mm ja 20 mm



5 KOKOA

30x60, 60x60, 60x120,
60,3x60,3, 90x90 cm



4 KORISTEAIHETTA

Mosaico 36 pezzi, Muretto 3D,
Quarter, Venice



594x1190 Rect

Naturale

Soft

Strutturato (20mm)*

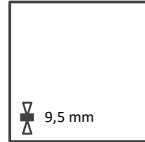

594x594 Rect

Naturale

Soft

Strutturato*



296x594 Rect

Naturale

Soft

Strutturato *

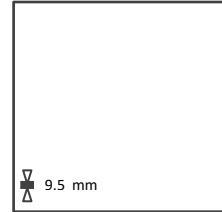

895x895 Rect

Naturale

Soft

Ext(ulkolaatta)*

- Square
- Loft
- Mansion

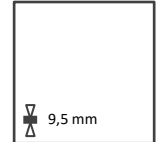

603x603

Naturale

* Ei antibakteerinen

Saatavana myös **Context Zero.3** – sarjan 6 mm paksuiset suuret seinälaatat
koossa 1200x2600 mm ja 1200x1200 mm (nimellismitat)





594x594x9,5 rect
Quarter
SQUARE



296x296x9,5 rect
Mosaiikki 36 palaa
SQUARE

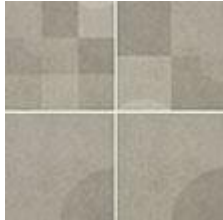

594x594x9,5 rect
Quarter
LOFT



296x296x10 rect
Mosaiikki 36 palaa
LOFT

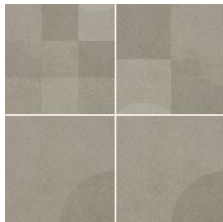

594x594x9,5 rect
Quarter
STORE



296x296x9,5 rect
Mosaiikki 36 palaa
STORE

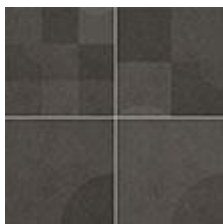

594x594x9,5 rect
Quarter
HANGAR



296x296x9,5 rect
Mosaiikki 36 palaa
HANGAR



296x296x9,5 rect
Mosaiikki 36 palaa
MANSION



594x594x9,5 rect
Quarter
MANSION



296x594x9,5 rect
Muretto 3D
MANSION

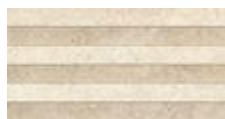

296x594x9,5 rect
Muretto 3D
SQUARE



296x594x9,5 rect
Muretto 3D
LOFT



296x594x9,5 rect
Muretto 3D
STORE



296x594x9,5rect
Muretto 3D
HANGAR



594x594x9,5 rect
Venice
SQUARE

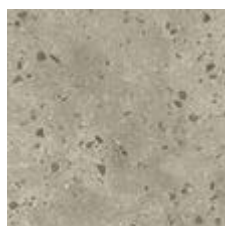

594x594x9,5 rect
Venice
LOFT

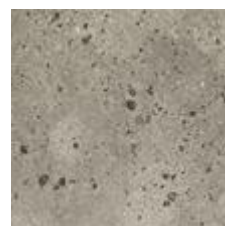

594x594x9,5 rect
Venice
STORE

Muotokappaleet 9-10 mm

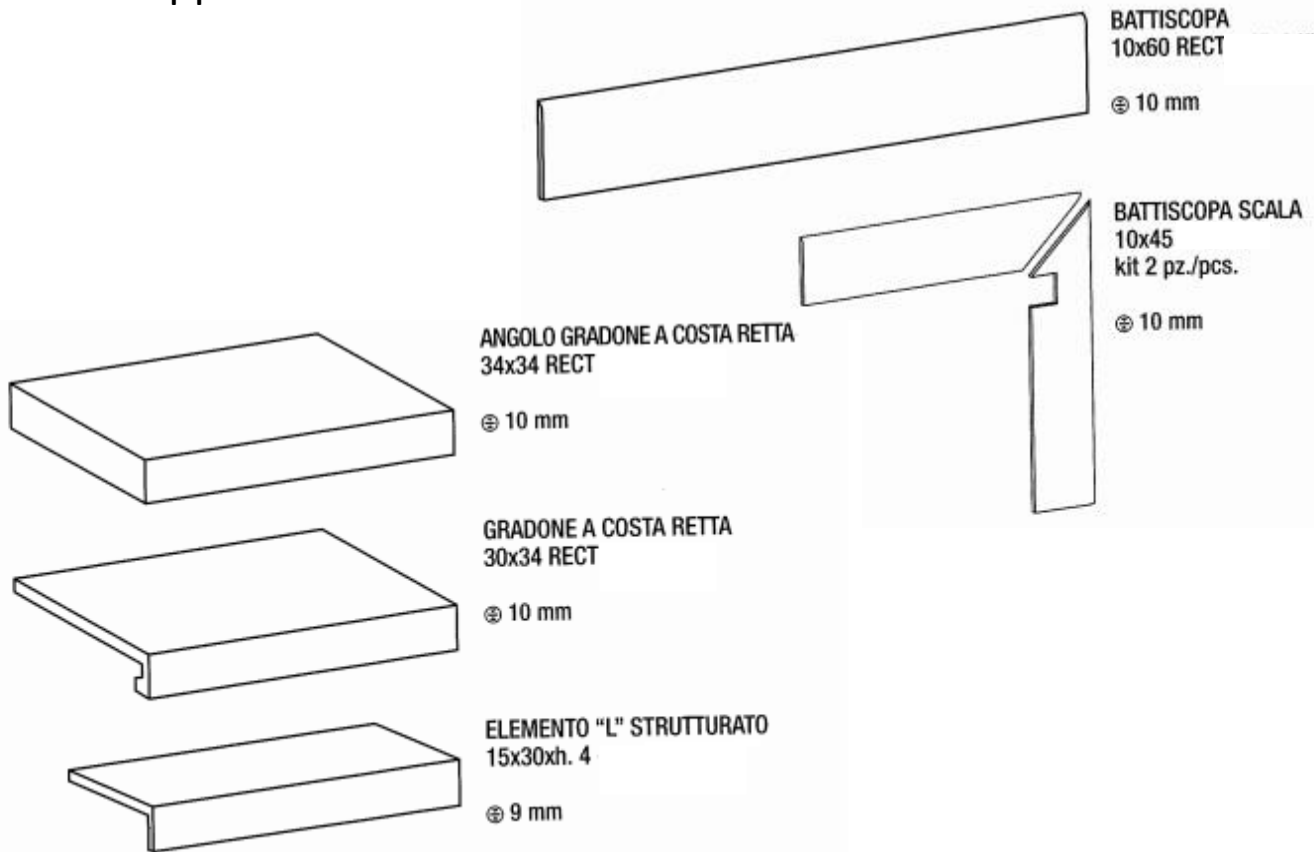

Muotokappaleet 20 mm

1 COSTA TORO ANGOLARE DX
30X60 RECT

2 COSTA TORO ANGOLARE DX
30X60 RECT

3 COSTA TORO
30X60 RECT

4 COSTA TORO GRIP
30X60 RECT

5 COSTA RETTA
30X60 RECT

6 COSTA RETTA GRIP
30X60 RECT

7 COSTA RETTA ANGOLARE DX
30X60 RECT

8 COSTA RETTA ANGOLARE SX
30X60 RECT

9 GRIGLIA
15X60 RECT

10 GRIGLIA ANGOLARE DX
15X60 RECT

11 GRIGLIA ANGOLARE SX
15X60 RECT

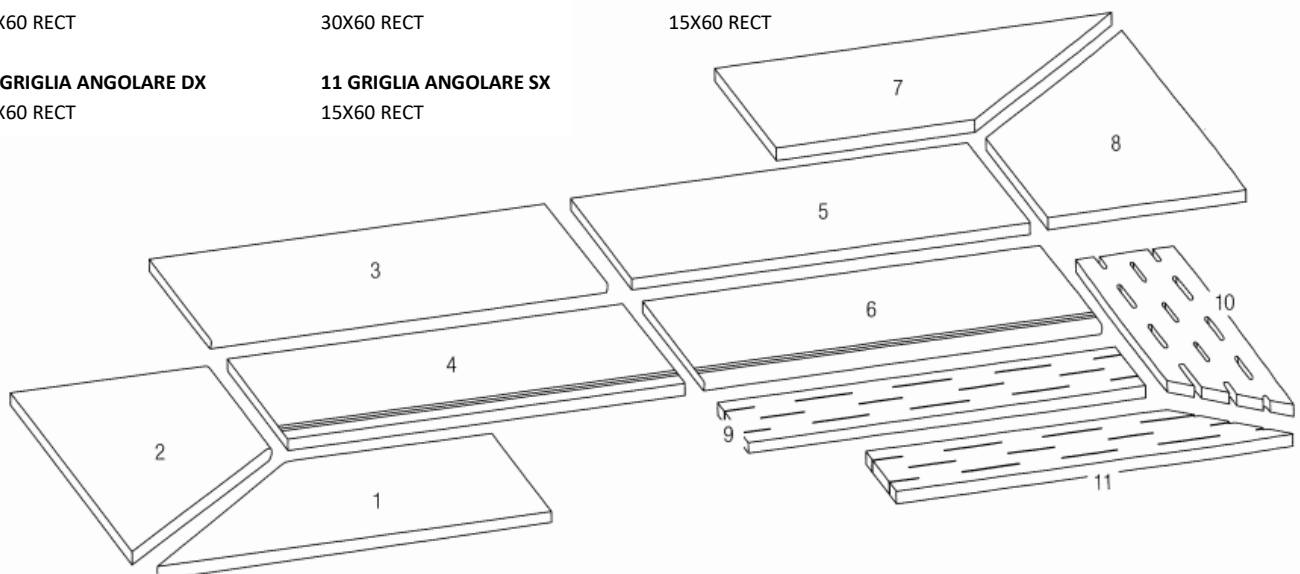

TEKNISET OMINAISUUDET
Panaria Context (V2) Lasittamaton kuivapuristelaatta (UGL)

Tekniset ominaisarvot	Testausmenetelmä	SFS-EN 14411-G vaatimukset keraamisille laatoille	Tehtaan ilmoittamat sarjan keskimääräiset arvot
Pituus ja leveys	ISO 10545-2	rect ± 0,3%, max ± 1 mm ± 0,6% , max ± 2 mm	täyttää
Sivujen suoruus	ISO 10545-2	rect ± 0,3%, max ± 0,8 mm ± 0,5% , max ± 1,5 mm	täyttää
Suorakulmaisuus	ISO 10545-2	rect± 0,3%, max ± 1,5 mm ± 0,5% , max ± 2 mm	täyttää
Paksuus	ISO 10545-2	± 5% , ± 0,5 mm	täyttää
Pinnan tasaisuus	ISO 10545-2	rect ± 0,4%, max ± 1,8 mm ± 0,5% , max ± 2 mm	täyttää
Vedenimukyky (E_b)	EN ISO 10545-3	≤ 0,5%	0,05 %
Taivutusvetolujuus	EN ISO 10545-4	≥ 35 N/mm ²	50 N/mm ²
Murtolujuus	EN ISO 10545-4	≥ 1300 N ≥ 700 N *)	(9,5 mm) 2200 N (20 mm) 13600 N
Kulutuskestävyys	EN ISO 10545-6	≤ 175 mm ³	145 mm³
Liukeesteluokitus	DIN 51130 DIN 51097		R10 nat. R11 strutturato,ext A+B naturale A+B+C str. ext
Pakkasenkestävyys	EN ISO 10545-12		pakkasen kestävä
Kemikaalien kestävyys (lukuun ottamatta fluorivetyhappo ja sen johdannaiset)	EN ISO 10545-13	Valmistajan lausunnon mukaan	LA,HA
Tahrojen kestävyys	EN ISO 10545-14	Class 3 min.	Class 5

Liukastumisenestoluokitus, julkisten tilojen lattiat DIN 51130

- R9 kuivat tilat, kauppakeskukset yms, luiskan kaltevuus enintään 10°
R10 vähän karhea liukestepinta, pesuhuoneet, kuivat sisätilat, sisääntuloaulat, luiskat 10-19°
R11 karhea liukestepinta, pesuhuoneet, teollisuuden tilat, suurtalouskeittiöt, terassit, luiskat 19-27°
R12 erittäin karhea, uimahallit, päiväkodit, terassit ja parvekkeet, luiskat 27-35°
R13 extra karheat, erikoistilat, elintarviketeollisuuden tilat joissa käsitellään rasvaa, luiskat yli 35°

Kosteiden tilojen lattiat missä liikutaan paljain jaloin DIN 51097

- A lievästi karhea, kuivat tilat, pukuhuoneet
B karhea, märät tilat, pesuhuoneet, uima-altaan ympärys
C erittäin karhea, tiloissa missä on tavallista suurempi liukastumisvaara, matalat uima-altaat vedenalaiset portaat, uima-altaan vierusta

Sävyvaihtelu laatoissa

- V1 minimaalinen
V2 vähäinen
V3 kohtalainen
V4 suuri





Happy Tiles 2020

25 vuotta