

**Panaria Context**



R10 Naturale  
R11 Strutturato, 20 mm



V2



Lasittamaton kuivapuristelaatta  
(UGL)

”Moderneja ja klassisia ratkaisuja, joissa yhdistyvät alkuperäisen materiaalin tyylikäs luonne keramiikan kestävyys ja toimivuuteen.”



Square



Loft



Store



Hangar



Mansion

20mm paksut laatat ulkokäyttöön

**PROTECT**  
SUPERFICIE ANTIBATTERICA  
ANTIMICROBIAL SURFACE  
with MICROBAN®



### 5 VÄRIÄ

SQUARE, LOFT,  
STORE, HANGAR,  
MANSION



### 2 PAKSUUTTA

9,5 mm ja 20 mm



### 5 KOKOA

30x60, 60x60, 60x120,  
60,3x60,3, 90x90 cm



### 4 KORISTEAIHETTA

Mosaico 36 pezzi, Muretto 3D,  
Quarter, Venice



594x1190 Rect  
Naturale  
Soft  
Strutturato (20mm)\*

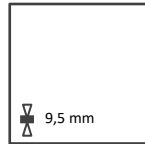

594x594 Rect  
Naturale  
Soft  
Strutturato\*



296x594 Rect  
Naturale  
Soft  
Strutturato \*

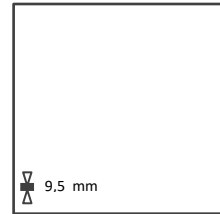

895x895 Rect  
Naturale  
Soft  
Ext(ulkolaatta)\*

- Square
- Loft
- Mansion

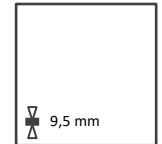

603x603  
Naturale

\* Ei antibakteerinen

Saatavana myös **Context Zero.3** – sarjan 6 mm paksuiset suuret seinälaatat  
koossa 1200x2600 mm ja 1200x1200 mm (nimellismitat)





**594x594x9,5 rect**  
Quarter  
SQUARE



**296x296x9,5 rect**  
Mosaiikki 36 palaa  
SQUARE

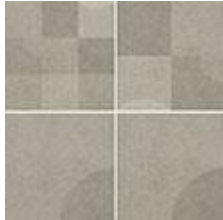

**594x594x9,5 rect**  
Quarter  
LOFT



**296x296x10 rect**  
Mosaiikki 36 palaa  
LOFT

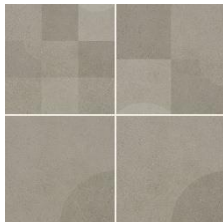

**594x594x9,5 rect**  
Quarter  
STORE



**296x296x9,5 rect**  
Mosaiikki 36 palaa  
STORE

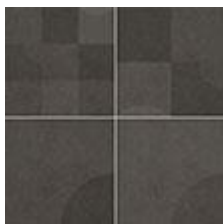

**594x594x9,5 rect**  
Quarter  
HANGAR



**296x296x9,5 rect**  
Mosaiikki 36 palaa  
HANGAR



**296x296x9,5 rect**  
Mosaiikki 36 palaa  
MANSION



**594x594x9,5 rect**  
Quarter  
MANSION



**296x594x9,5 rect**  
Muretto 3D  
MANSION

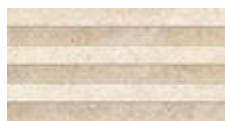

**296x594x9,5 rect**  
Muretto 3D  
SQUARE



**296x594x9,5 rect**  
Muretto 3D  
LOFT



**296x594x9,5 rect**  
Muretto 3D  
STORE



**296x594x9,5 rect**  
Muretto 3D  
HANGAR



**594x594x9,5 rect**  
Venice  
SQUARE

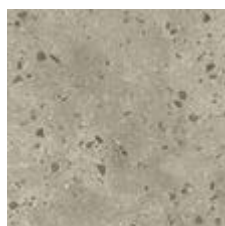

**594x594x9,5 rect**  
Venice  
LOFT

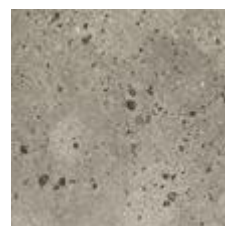

**594x594x9,5 rect**  
Venice  
STORE



## Muotokappaleet 9-10 mm

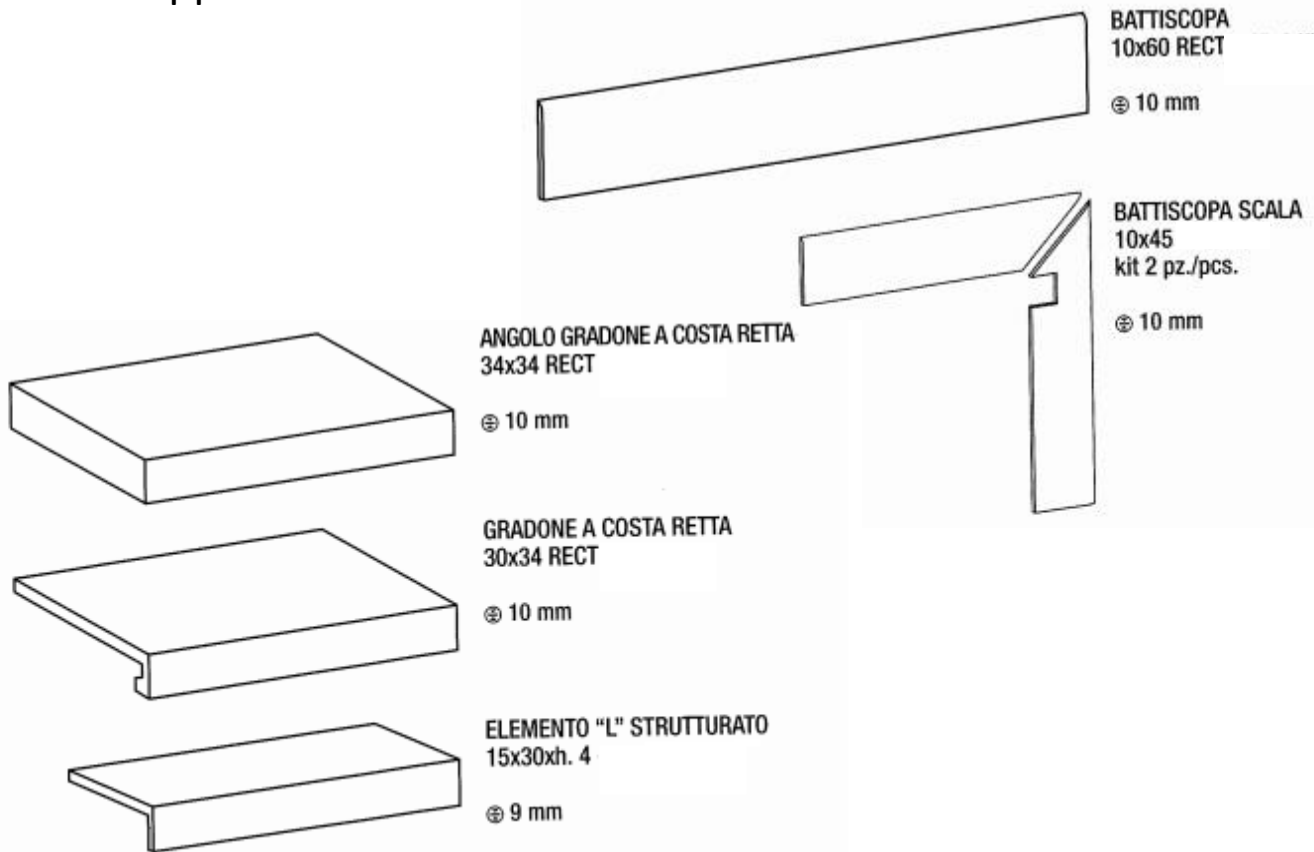

## Muotokappaleet 20 mm

**1 COSTA TORO ANGOLARE DX**  
30X60 RECT

**2 COSTA TORO ANGOLARE DX**  
30X60 RECT

**3 COSTA TORO**  
30X60 RECT

**4 COSTA TORO GRIP**  
30X60 RECT

**5 COSTA RETTA**  
30X60 RECT

**6 COSTA RETTA GRIP**  
30X60 RECT

**7 COSTA RETTA ANGOLARE DX**  
30X60 RECT

**8 COSTA RETTA ANGOLARE SX**  
30X60 RECT

**9 GRIGLIA**  
15X60 RECT

**10 GRIGLIA ANGOLARE DX**  
15X60 RECT

**11 GRIGLIA ANGOLARE SX**  
15X60 RECT

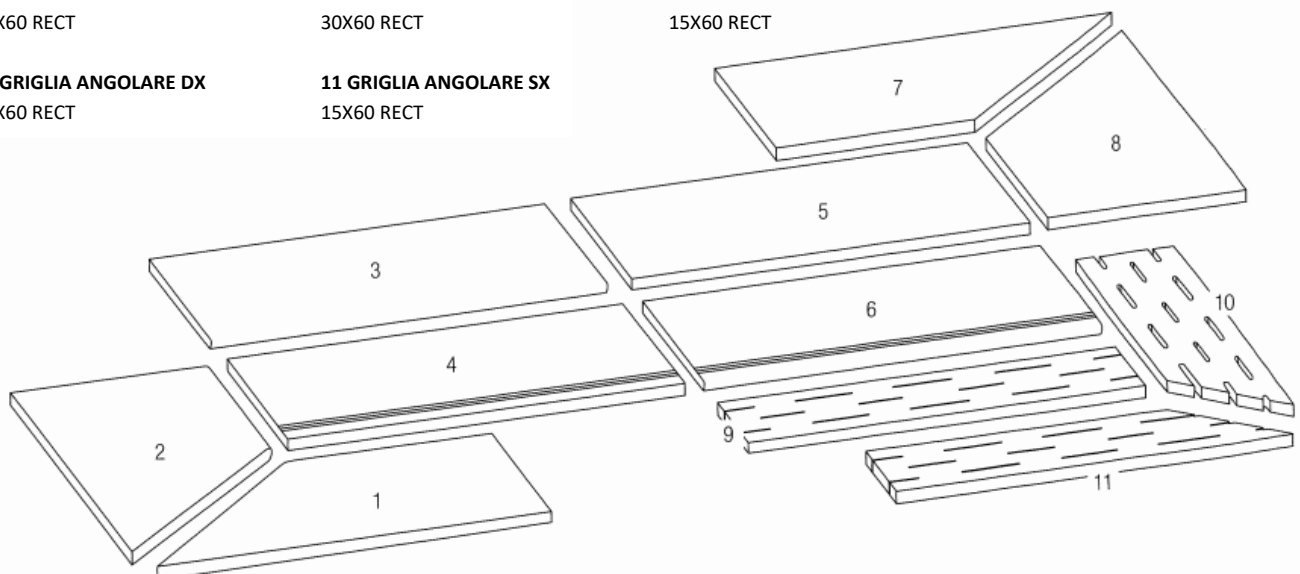

**TEKNISET OMINAISUUDET**
**Panaria Context (V2) Lasittamaton kuivapuristelaatta (UGL)**

Tekniset ominaisarvot	Testausmenetelmä	SFS-EN 14411-G vaatimukset keraamisille laatoille	Tehtaan ilmoittamat sarjan keskimääräiset arvot
Pituus ja leveys	ISO 10545-2	rect ± 0,3%, max ± 1 mm ± 0,6% , max ± 2 mm	täyttää
Sivujen suoruus	ISO 10545-2	rect ± 0,3%, max ± 0,8 mm ± 0,5% , max ± 1,5 mm	täyttää
Suorakulmaisuus	ISO 10545-2	rect± 0,3%, max ± 1,5 mm ± 0,5% , max ± 2 mm	täyttää
Paksuus	ISO 10545-2	± 5% , ± 0,5 mm	täyttää
Pinnan tasaisuus	ISO 10545-2	rect ± 0,4%, max ± 1,8 mm ± 0,5% , max ± 2 mm	täyttää
<b>Vedenimukyky (E<sub>b</sub>)</b>	EN ISO 10545-3	≤ 0,5%	<b>0,05 %</b>
<b>Taivutusvetolujuus</b>	EN ISO 10545-4	≥ 35 N/mm <sup>2</sup>	50 N/mm <sup>2</sup>
<b>Murtolujuus</b>	EN ISO 10545-4	≥ 1300 N ≥ 700 N *)	(9,5 mm) <b>2200 N</b> (20 mm) <b>13600 N</b>
<b>Kulutuskestävyys</b>	EN ISO 10545-6	≤ 175 mm <sup>3</sup>	<b>145 mm<sup>3</sup></b>
<b>Liukeesteluokitus</b>	DIN 51130 DIN 51097		<b>R10 nat.</b> <b>R11 strutturato,ext</b> <b>A+B naturale</b> <b>A+B+C str. ext</b>
Pakkasenkestävyys	EN ISO 10545-12		pakkasen kestävä
Kemikaalien kestävyys (lukuun ottamatta fluorivetyhappo ja sen johdannaiset)	EN ISO 10545-13	Valmistajan lausunnon mukaan	LA,HA
Tahrojen kestävyys	EN ISO 10545-14	Class 3 min.	Class 5

**Liukastumisenestoluokitus, julkisten tilojen lattiat DIN 51130**

- R9 kuivat tilat, kauppakeskukset yms, luiskan kaltevuus enintään 10°  
R10 vähän karhea liukestepinta, pesuhuoneet, kuivat sisätilat, sisääntuloaulat, luiskat 10-19°  
R11 karhea liukestepinta, pesuhuoneet, teollisuuden tilat, suurtalouskeittiöt, terassit, luiskat 19-27°  
R12 erittäin karhea, uimahallit, päiväkodit, terassit ja parvekkeet, luiskat 27-35°  
R13 extra karheat, erikoistilat, elintarviketeollisuuden tilat joissa käsitellään rasvaa, luiskat yli 35°

**Kosteiden tilojen lattiat missä liikutaan paljain jaloin DIN 51097**

- A lievästi karhea, kuivat tilat, pukuhuoneet  
B karhea, märät tilat, pesuhuoneet, uima-altaan ympärys  
C erittäin karhea, tiloissa missä on tavallista suurempi liukastumisvaara, matalat uima-altaat vedenalaiset portaat, uima-altaan vierusta

**Sävyvaihtelu laatoissa**

- V1 minimaalinen  
V2 vähäinen  
V3 kohtalainen  
V4 suuri



